

J+J®
www.jjbcn.com

J.J. BCN INTERNACIONAL, S.A. se reserva el derecho de modificación del diseño, construcción o cualquier detalle técnico de los productos que figuran en este catálogo sin previo aviso.

GARANTIA
Los actuadores J+J están garantizados contra vicios de fabricación o montaje como sigue:
Serie J4C S/B: 60.000 ciclos o 3 años a partir de la fecha de expedición. Duty 75%. Número máximo limitaciones 50 dentro de los 3 años de garantía.

Es imprescindible, en todos los casos, que la etiqueta identificativa sea legible y permita su fácil identificación. NUESTRA GARANTÍA COMPRENDE ÚNICAMENTE LA REPARACIÓN O SUSTITUCIÓN DE LAS PIEZAS DEFECTUOSAS SIEMPRE Y CUANDO LOS POSIBLES DEFECTOS HAYAN SIDO COMPROBADOS EN NUESTROS TALLERES O IN SITU NO ATENDIENDO A INDEMNIFICACIONES NI A OTROS GASTOS. La garantía pierde su validez si las unidades han sido manipuladas, si los defectos son consecuencia de trato incorrecto, aplicación indebida, reparaciones o modificaciones llevadas a cabo fuera de nuestros talleres o hayan sido instalados con materiales o procedimientos fuera de NORMAS. La parte que alegue la existencia de un defecto de fabricación deberá acreditar la utilización adecuada del producto y en su caso la correcta instalación del mismo. Los cargos de devolución y reenvío de los materiales defectuosos serán por cuenta del comprador.



J4CV04

J.J. BCN INTERNACIONAL, S.A. reserves the right to change or modify the design, technical details or construction of the products of this catalogue without prior notice.

GUARANTEE
J+J actuators are warranted against defects of workmanship or assembly as follows:
J4C S/B Series: up to 60,000 working cycles or 3 years from their shipment date. Working conditions of a 75% of duty. Max number of 50 limiter function activations, within 3 years of the warranty period.

The actuator identification label should be legible and easily allow the actuator identification. This is compulsory in all cases. OUR WARRANTY INCLUDES SOLELY AND EXCLUSIVELY THE REPAIR OR REPLACEMENT OF THE DEFECTIVE PARTS IN OUR WORKSHOP OR IN THE PLACEMENT OF THE INSTALLATION AND DOES NOT COVER INDEMNIFICATIONS OR OTHER EXPENSES. The warranty will be void if the device has been opened, if the defects are the result of the misuse or if our products have been handled, repaired or modified outside our workshop or have been installed with materials or by methods not in accordance with our STANDARDS. The party alleging the existence of a defect of workmanship shall accredit the suitable use of the product and, if appropriate the correct installation of the same. The expenses of the return and reshipment of the defective materials will be for the account of the buyer.

J4C

multivoltaje total
all voltages

ELECTRIC POWER

actuadores eléctricos
electric actuators



20Nm
v
300Nm

IP67

75%
Duty rating

Electronic
Torque
Limiter

Automatic
Temperature
Control

Battery
System
Returns

Digital
Positioner
System

Bluetooth

Modbus

J.J. BCN INTERNACIONAL S.A.



J4 TECNOLOGÍA BRUSHLESS BRUSHLESS TECHNOLOGY

Si siguiendo con la filosofía del actuador **multivoltaje total**, incorporamos a nuestra gama de actuadores eléctricos, la **serie J4**, la cual introduce por primera vez, el motor **brushless**. El **motor brushless** es un motor más robusto, más eficiente y necesita menos mantenimiento que un motor de escobillas. Todo esto contribuye a **prolongar la vida** de nuestros actuadores.

Lanzamos la **gama completa**, desde 20Nm a 300Nm, cuyos modelos **B** trabajan a **12VAC/VDC**, los **S** desde **24 a 240 VAC 50/60Hz** y a **24 a 135VDC** y los **H** desde **85 a 240 VDC/-VAC 50/60Hz** indistintamente.

Su avanzada tecnología los capacita para comunicarse, de manera inteligente, utilizando el protocolo **MODBUS** o vía **BLUETOOTH**.

Dichos sistemas de comunicación aparecen como **"opciones de fábrica"** en nuestro catálogo.

Without leaving our philosophy of **total multivoltage** actuators, we would like to introduce, in our range of electric actuators, the **new J4 series**, which works, for the first time, with a **brushless motor**.

The **brushless motor** is stronger, more efficient and with less maintenance than a brushed motor. It definitely contributes to **enlarge our actuators life**.

We are launching a **complete range** of torques, from 20Nm to 300Nm, which **B** models work at **12VAC/VDC**, **S** models do the same from **24 to 240 VAC 50/60Hz** & **24 to 135VDC** and **H** models from **85 to 240 VDC/VAC 50/60Hz**.

Its high level technology, makes our actuators capable to intelligently communicate, using both the **MODBUS** protocol or via **BLUETOOTH**.

The mentioned communication systems appear as **"factory options"** in our catalogue.

www.jjbcn.com

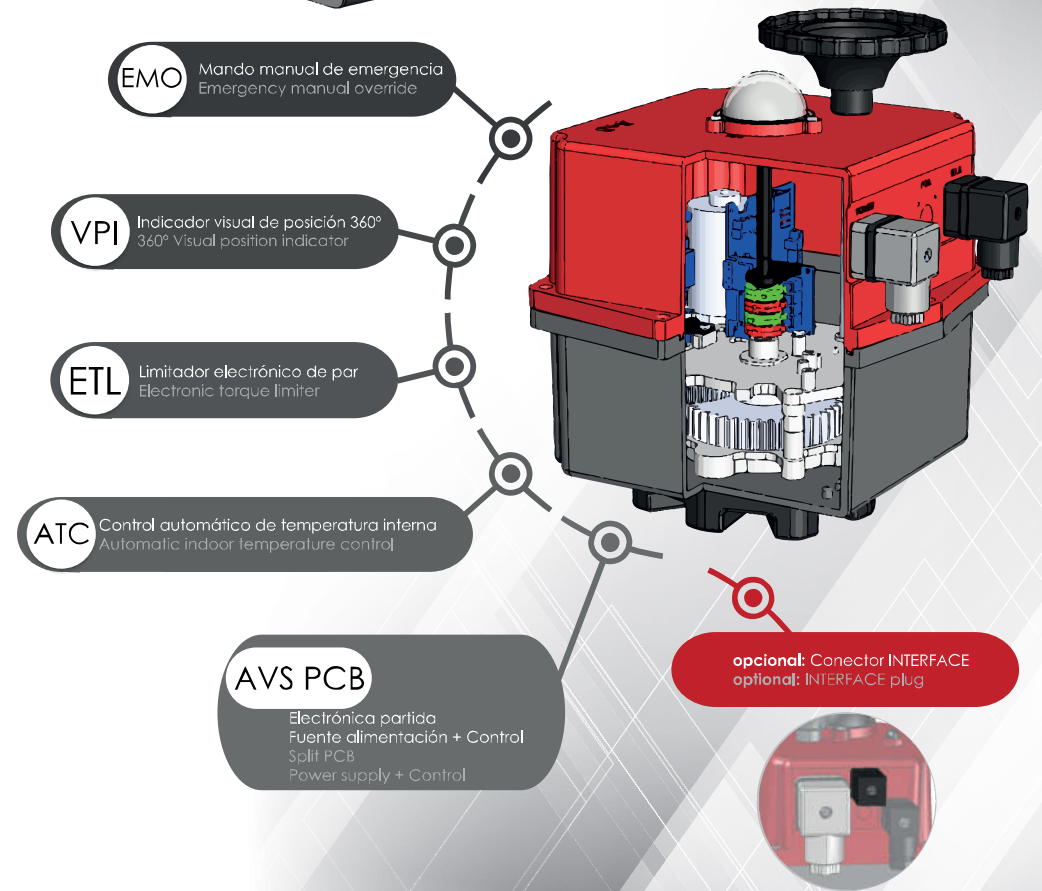
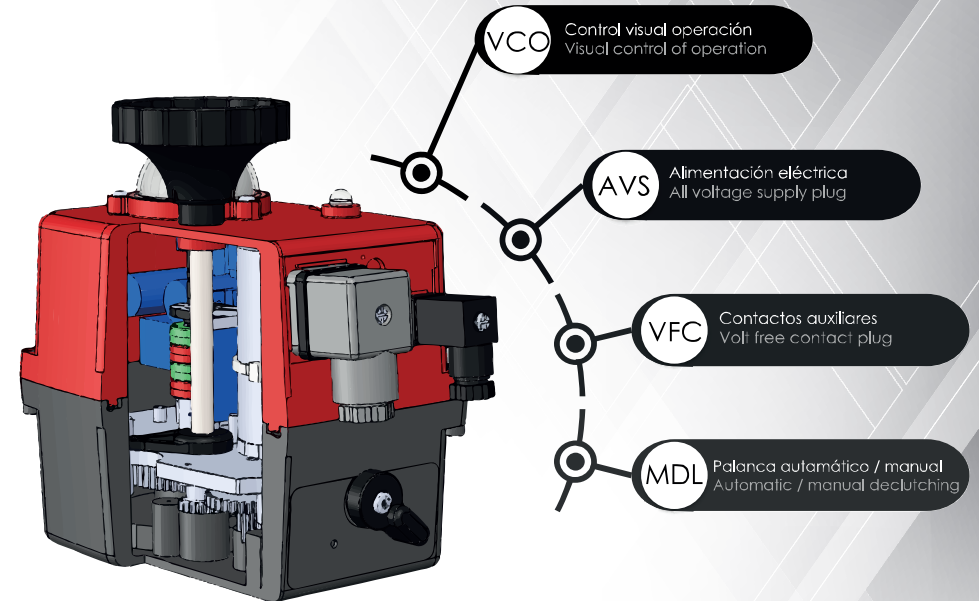

especificaciones / specifications

| Série / Series | Modelo / Model | Voltaje / Voltage | Série / Series | Modelo / Model | Voltaje / Voltage | Série / Series | Modelo / Model | Voltaje / Voltage |
|----------------|---------------------------|--|----------------|---------------------------|---------------------------|----------------|---------------------------|------------------------------------|
| J4 | S20 S35 S55 S85 S140 S300 | 24 a 10 240 VAC 50/60Hz -0/+5% 24 a 10 135 VDC -0/+5% | J4 | B20 B35 B55 B85 B140 B300 | 12 VDC/VAC 50/60Hz -0/+5% | J4 | H20 H35 H55 H85 H140 H300 | 85 a 10 240 VAC/VDC 50/60Hz -0/+5% |

| Série Modelo / Series Model | J4 S20/B20/H20 | J4 S35/B35/H35 | J4 S55/B55/H55 | J4 S85/B85/H85 | J4 S140/B140/H140 | J4 S300/B300/H300 |
|--|--|--|--|--|--|--|
| Tiempo maniobra sin carga / Operation time unload | 9 Sec./90° | 9 Sec./90° | 13 Sec./90° | 29 Sec./90° | 34 Sec./90° | 58 Sec./90° |
| Par máximo arranque / Maximum torque break | 25 Nm / 221 lb/in | 38 Nm / 359.3 lb/in | 60 Nm / 530 lb/in | 90 Nm / 796.3 lb/in | 170 Nm / 1504.5 lb/in | 350 Nm / 3097.5 lb/in |
| Par máximo operacional / Maximum operational torque | 20 Nm / 177 lb/in | 35 Nm / 309 lb/in | 55 Nm / 486 lb/in | 85 Nm / 752 lb/in | 140 Nm / 1239 lb/in | 300 Nm / 2655 lb/in |
| Tiempo bajo tensión / Duty rating | 75% | 75% | 75% | 75% | 75% | 75% |
| Ángulo máximo de maniobra / Max. Working angle | 0° - 270° | 0° - 270° | 0° - 270° | 0° - 270° | 0° - 270° | 0° - 270° |
| Interruptores final de carrera / Limit switch | 4 SPST NO micro (2 motor stop and 2 confirmations) | 4 SPST NO micro (2 motor stop and 2 confirmations) | 4 SPST NO micro (2 motor stop and 2 confirmations) | 4 SPST NO micro (2 motor stop and 2 confirmations) | 4 SPST NO micro (2 motor stop and 2 confirmations) | 4 SPST NO micro (2 motor stop and 2 confirmations) |
| Resistencia calefactora / Automatic heater | 3.5 W | 3.5 W | 3.5 W | 3.5 W | 3.5 W | 3.5 W |
| Conector grande / Big Plug | EN175301-803 FORM A | EN175301-803 FORM A | EN175301-803 FORM A | EN175301-803 FORM A | EN175301-803 FORM A | EN175301-803 FORM A |
| Conector pequeño / Small Plug | DIN43650/C | DIN43650/C | DIN43650/C | DIN43650/C | DIN43650/C | DIN43650/C |
| Grado protección IEC 60529 / Protection IEC 60529 rating | IP67 | IP67 | IP67 | IP67 | IP67 | IP67 |
| Temperatura / Temperature | -20°C +70°C -4°F +158°F | -20°C +70°C -4°F +158°F | -20°C +70°C -4°F +158°F | -20°C +70°C -4°F +158°F | -20°C +70°C -4°F +158°F | -20°C +70°C -4°F +158°F |
| Brida ISO 5211 / ISO 5211 Plate | Standard: F03/F04/F05 Optional: F07 *17mm | Standard: F03/F04/F05 Optional: F07 *17mm | F05/F07 | F05/F07 | Standard: F07/F10 Optional: F12 | Standard: F07/F10 Optional: F12 |
| Salida doble cuadrado DIN3337 DIN 3337 Female output drive | Standard: *14mm Optional: *9, *11mm | Standard: *14mm Optional: *9, *11mm | Standard: *17mm Optional: *11, *14mm | Standard: *17mm Optional: *14mm | Standard: *22mm Optional: *17mm | Standard: *22mm Optional: *17mm |
| Peso / Weight | 1.8 Kg | 1.9 Kg | 2.4 Kg | 3 Kg | 5.2 Kg | 5.2 Kg |
| OPCIONES / OPTIONS | | | | | | |
| J4C KIT DPS Posicionador digital J4C KIT DPS Digital positioner | 4-20mA, 0-20mA, 0-10V or 1-10V | 4-20mA, 0-20mA, 0-10V or 1-10V | 4-20mA, 0-20mA, 0-10V or 1-10V | 4-20mA, 0-20mA, 0-10V or 1-10V | 4-20mA, 0-20mA, 0-10V or 1-10V | 4-20mA, 0-20mA, 0-10V or 1-10V |
| J4C KIT BSR sistema retorno por batería J4C KIT BSR emergency fail safe kit system by battery | NC - NO | NC - NO | NC - NO | NC - NO | NC - NO | NC - NO |
| Potenciometro digital / Digital potentiometer | 1K, 5K, 10k | 1K, 5K, 10k | 1K, 5K, 10k | 1K, 5K, 10k | 1K, 5K, 10k | 1K, 5K, 10k |
| Actuador con 3 posiciones / 3 position actuator | 0°-45°-90°, 0°-90°-180° | 0°-45°-90°, 0°-90°-180° | 0°-45°-90°, 0°-90°-180° | 0°-45°-90°, 0°-90°-180° | 0°-45°-90°, 0°-90°-180° | 0°-45°-90°, 0°-90°-180° |

tabla de consumos / table of consumptions

| | J4 S20/B20/H20 | | | | | | J4 S35/B35/H35 | | | | | | J4 S55/B55/H55 | | | | | | J4 S85/B85/H85 | | | | | | J4 S140/B140/H140 | | | | | | J4 S300/B300/H300 | | | | | |
|---------|----------------|-------|------------------------------|-------|------------------------|-------|----------------|-------|------------------------------|-------|------------------------|-------|----------------|-------|------------------------------|-------|------------------------|-------|----------------|-------|------------------------------|-------|------------------------|-------|-------------------|-------|-------------------------------|-------|-------------------------|--------|-------------------|--------|-------------------------------|-------|-------------------------|--------|
| | Unload | | Max. Operational Torque 20Nm | | Max. Torque Break 25Nm | | Unload | | Max. Operational Torque 35Nm | | Max. Torque Break 38Nm | | Unload | | Max. Operational Torque 55Nm | | Max. Torque Break 60Nm | | Unload | | Max. Operational Torque 85Nm | | Max. Torque Break 90Nm | | Unload | | Max. Operational Torque 140Nm | | Max. Torque Break 170Nm | | Unload | | Max. Operational Torque 300Nm | | Max. Torque Break 350Nm | |
| Voltage | A | W | A | W | A | W | A | W | A | W | A | W | A | W | A | W | A | W | A | W | A | W | A | W | A | W | A | W | A | W | A | W | A | W | | |
| 12 VDC | 0.75 | 9.06 | 1.80 | 21.60 | 1.95 | 23.36 | 0.75 | 9.06 | 2.38 | 28.62 | 2.62 | 31.50 | 0.70 | 8.45 | 3.04 | 36.43 | 3.42 | 41.05 | 0.62 | 7.42 | 2.11 | 25.34 | 2.28 | 27.32 | 1.93 | 23.10 | 4.73 | 56.76 | 5.39 | 64.68 | 1.32 | 15.84 | 5.17 | 62.04 | 5.45 | 65.34 |
| 24 VDC | 0.45 | 10.77 | 0.80 | 21.49 | 0.97 | 23.39 | 0.45 | 10.77 | 1.28 | 30.78 | 1.37 | 32.79 | 0.42 | 10.19 | 1.55 | 37.17 | 1.63 | 39.02 | 0.36 | 8.55 | 1.08 | 25.87 | 1.22 | 29.30 | 0.66 | 15.84 | 2.15 | 51.48 | 2.53 | 60.72 | 0.50 | 11.88 | 2.31 | 55.44 | 2.70 | 64.68 |
| 48 VDC | 0.21 | 9.93 | 0.42 | 20.38 | 0.46 | 22.07 | 0.21 | 9.93 | 0.56 | 26.72 | 0.59 | 28.20 | 0.20 | 9.72 | 0.61 | 29.25 | 0.67 | 32.31 | 0.17 | 8.24 | 0.48 | 22.92 | 0.53 | 25.56 | 0.30 | 14.25 | 0.88 | 42.24 | 1.10 | 52.80 | 0.22 | 10.56 | 1.10 | 52.80 | 1.19 | 57.02 |
| 110 VDC | 0.07 | 8.00 | 0.13 | 14.30 | 0.14 | 15.70 | 0.07 | 7.70 | 0.17 | 18.90 | 0.18 | 20.10 | 0.07 | 7.50 | 0.19 | 20.80 | 0.21 | 23.20 | 0.05 | 5.80 | 0.14 | 15.20 | 0.16 | 17.90 | 0.10 | 10.89 | 0.28 | 30.25 | 0.39 | 42.35 | 0.09 | 9.66 | 0.33 | 36.30 | 0.39 | 42.35 |
| 12 VAC | 1.04 | 12.51 | 1.85 | 22.18 | 2.28 | 27.32 | 1.04 | 12.51 | 2.75 | 33.00 | 3.19 | 38.28 | 0.94 | 11.30 | 3.43 | 41.18 | 3.78 | 45.41 | 0.81 | 9.69 | 2.38 | 28.51 | 2.65 | 31.81 | 2.75 | 33.00 | 6.60 | 79.20 | 8.47 | 101.64 | 1.98 | 23.76 | 7.26 | 87.12 | 8.64 | 103.62 |
| 24 VAC | 0.59 | 14.20 | 1.12 | 26.77 | 1.28 | 30.62 | 0.59 | 14.20 | 1.58 | 37.80 | 1.67 | 40.13 | 0.58 | 13.89 | 1.87 | 44.88 | 1.98 | 47.52 | 0.50 | 11.88 | 1.36 | 32.74 | 1.50 | 36.01 | 0.83 | 19.80 | 2.59 | 62.04 | 3.30 | 79.20 | 0.66 | 15.84 | 2.75 | 66.00 | 3.30 | 79.20 |
| 48 VAC | 0.34 | 16.37 | 0.69 | 33.16 | 0.75 | 36.22 | 0.34 | 16.37 | 0.92 | 44.04 | 0.99 | 47.31 | 0.33 | 15.73 | 1.10 | 52.80 | 1.21 | 58.29 | 0.25 | 11.83 | 0.77 | 37.07 | 0.86 | 41.18 | 0.48 | 23.23 | 1.43 | 68.64 | 1.79 | 86.06 | 0.36 | 17.42 | 1.65 | 79.20 | 1.87 | 89.76 |
| 110 VAC | 0.14 | 15.73 | 0.27 | 29.52 | 0.30 | 32.67 | 0.14 | 15.73 | 0.36 | 39.45 | 0.38 | 41.87 | 0.14 | 15.73 | 0.40 | 49.80 | 0.43 | 46.95 | 0.12 | 12.83 | 0.31 | 33.64 | 0.33 | 36.54 | 0.23 | 25.41 | 0.63 | 68.97 | 0.72 | 78.65 | 0.19 | 20.57 | 0.66 | 72.60 | 0.77 | 84.70 |
| 240 VAC | 0.10 | 23.76 | 0.15 | 36.43 | 0.16 | 39.07 | 0.10 | 23.76 | 0.19 | 45.41 | 0.20 | 47.52 | 0.09 | 22.70 | 0.20 | 47.52 | 0.21 | 50.16 | 0.08 | 20.06 | 0.17 | 40.13 | 0.18 | 42.77 | 0.18 | 42.24 | 0.39 | 92.40 | 0.44 | 100.32 | 0.47 | 113.52 | | | | |

esquema externo de conexiones / external wiring

ABRE - CIERRA 3 CABLES / 3 WIRES ON - OFF

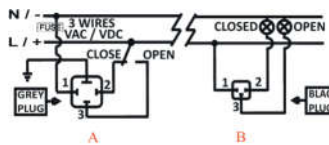

A = Alimentación eléctrica / Power supply plug
A: VAC 3 CABLES (Conector gris) / VAC 3 WIRES (Grey plug)
 PIN 1 = Neutral + PIN 2 = Phase = Cierre / Close
 PIN 1 = Neutral + PIN 3 = Phase = Abre / Open
A: VDC 3 CABLES (Conector gris) / VDC 3 WIRES (Grey plug)
 PIN 1 = (-) Negative + PIN 2 = (+) Positive = Cierre / Close
 PIN 1 = (-) Negative + PIN 3 = (+) Positive = Abre / Open

B = Contactos auxiliares / Volt free contact plug
 PIN 1 / PIN 2 = Cierre / Close
 PIN 1 / PIN 3 = Abre / Open

ABRE - CIERRA 2 CABLES / 2 WIRES ON - OFF

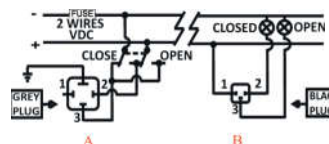

A = Alimentación eléctrica / Power supply plug
A: VDC 2 CABLES (Conector gris) / VDC 2 WIRES (Grey plug)
 PIN 2 = (+) Positive + PIN 3 = (-) Negative = Cierre / Close
 PIN 2 = (-) Negative + PIN 3 = (+) Positive = Abre / Open

B = Contactos auxiliares / Volt free contact plug
 PIN 1 / PIN 2 = Cierre / Close
 PIN 1 / PIN 3 = Abre / Open

POSICIONADOR / POSITIONER

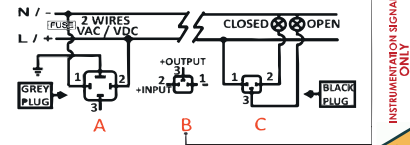

A = Alimentación eléctrica / Power supply plug
A: VAC 2 CABLES (Conector gris) / VAC 2 WIRES (Grey plug)
 PIN 1 = Neutral + PIN 2 = Phase = Alimentación eléctrica / Power supply plug
A: VDC 2 CABLES (Conector gris) / VDC 2 WIRES (Grey plug)
 PIN 1 = (-) Negative + PIN 2 = (+) Positive = Alimentación eléctrica / Power supply plug

B = Señal de instrumentación / Instrumentation signal
B: Señal de entrada: 4/20mA o 0/10V / Input signal: 4/20mA o 0/10V
 PIN 1 = (-) Negative + PIN 2 = (+) Positive = Señal de entrada / Input signal
 PIN 1 = (-) Negative + PIN 3 = (+) Positive = Señal de salida / Output signal
C = Contactos auxiliares / Volt free contact plug
 PIN 1 / PIN 2 = Cerrado / Closed
 PIN 1 / PIN 3 = Abierto / Open

Las especificaciones y rendimientos del equipo son nominales y se entiende que su aplicación será de acuerdo con los estándares del sector. Para aplicaciones y condiciones de trabajo que excedan de las especificaciones generales consultar con el distribuidor. J.J. BCN INTERNACIONAL, S.A. no se responsabiliza de ningún tipo de daño que resulte de la aplicación errónea o fuera de normas para las que el actuador ha sido diseñado. Para el cálculo del actuador a aplicar de acuerdo con el par de la válvula, tener en cuenta siempre que debe sumarse el coeficiente de seguridad de par nominal de la válvula.

The specifications and performance of the actuator are nominal and it is understood that its application will be in accordance with industry standards. For applications and working conditions that exceed the general specifications please contact to the distributor. J.J. BCN INTERNACIONAL, S. A. is not responsible for any harm resulting from the misapplication or outside norms for which the actuator has been designed. For the correct calculation of the model of actuator to apply according to the valve torque, always bear in mind that you must join the safety coefficient to the nominal torque of the valve.

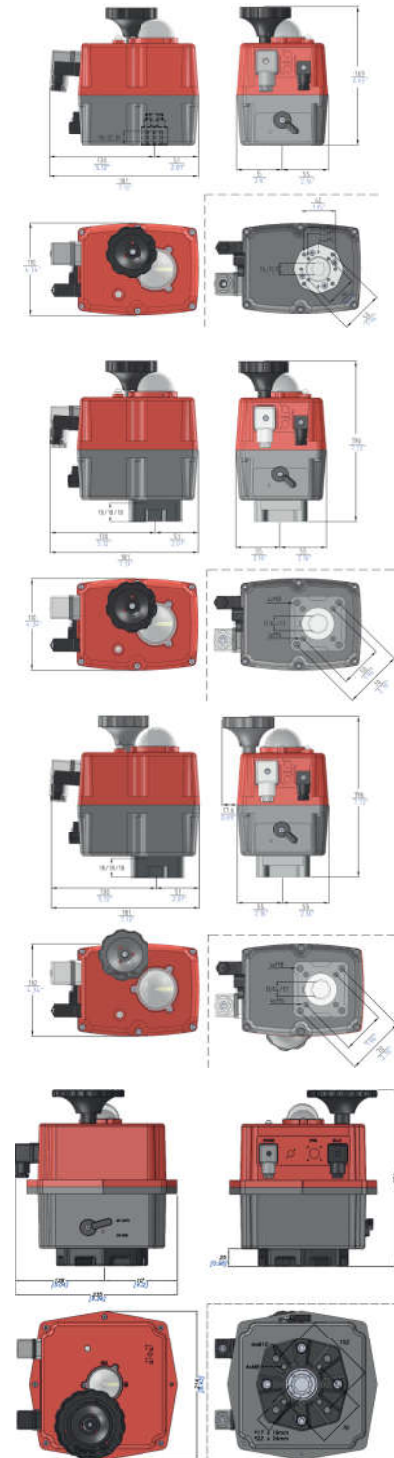



opciones de fábrica // factory options

- Posicionador digital **DPS**: 4-20mA, 0-20mA, 0-10V o 1-10V
DPS digital positioner: 4-20mA, 0-20mA, 0-10V or 1-10V
- Sistema **BSR** retorno emergencia por batería / **BSR** Battery system returns
- Potenciómetro digital: 1K, 5K o 10K / Digital potentiometer: 1K, 5K or 10K
- Actuador con 3 posiciones: 0°-45°-90° o 0°-90°-180° / 3 position actuator: 0°-45°-90° or 0°-90°-180°
- Conector Interface / Interface plug
- Comunicación **Modbus** vía cable o Wifi / **Modbus** interface module wired or Wifi
- Comunicación **Bluetooth** / **Bluetooth** module
- Para otras opciones, consultar / Other options on request



kits automontaje // self-mounting kits



Interface System

A través del cable del KIT INTERFACE establecemos comunicación con el actuador, leemos parámetros y cambiamos la configuración del actuador.

Using the Interface Kit cable we communicate with the actuator, read parameters and change the actuators configuration.



Battery System Returns

Sistema BSR para nuestros modelos desde 20Nm a 85Nm. Se trata de un sistema de retorno por batería que es común a los modelos S, B y H. El mismo sistema BSR se ha desarrollado para nuestros modelos de 140Nm y 300Nm pero con una batería de mayor capacidad.

BSR system for our 20Nm to 85Nm models. It is an emergency fail safe kit system by battery which is common to both S, B and H models. The BSR system for our models 140Nm and 300Nm is the same but with a bigger capacity battery.



Digital Positioner System 20-85

Posicionador digital para nuestros modelos desde 20Nm a 85Nm. Señal de instrumentación 4-20mA, 0-20mA, 0-10V o 1-10V. Este posicionador es adecuado para los modelos S, B y H.

Digital positioner for our models from 20Nm to 85Nm. Instrumentation signal 4-20mA, 0-20mA, 0-10V or 1-10V signal. This DPS digital positioner is suitable for S, B and H models.



Digital Positioner System 140-300

Posicionador digital para nuestros modelos 140Nm y 300Nm. Señal de instrumentación 4-20mA, 0-20mA, 0-10V o 1-10V. Este posicionador es adecuado para los modelos S, B y H.

Digital positioner for our models 140Nm and 300Nm. Instrumentation signal 4-20mA, 0-20mA, 0-10V or 1-10V signal. This DPS digital positioner is suitable for S, B and H models.

infographic bluetooth technology



Hemos incorporado el sistema de comunicación **BLUETOOTH**, para poder comunicarnos con nuestros actuadores, desde cualquier dispositivo **IOS** o **ANDROID**. Dicho sistema aparece como una opción de fábrica en nuestro catálogo. Desde nuestro móvil o tablet podemos ordenar al actuador que abra/cierre o se pare en un punto, podemos informarnos de su estado actual, leer parámetros, conocer errores o incidencias, etc. La comunicación con nuestros dispositivos permanece protegida con una contraseña. Vía **BLUETOOTH** detectamos hasta un máximo de 50 actuadores a una distancia máxima de 20m.

We have introduced the **BLUETOOTH** communication system in our actuators, in order to communicate with our actuators, from any **IOS** or **ANDROID** devices. This system appears in our catalogue as a factory option. From our mobile phone or tablet we could order our actuator to open/close or stop, we could be informed about its status, read parameters, know about errors or incidences, etc. The communication between our devices is protected by a password. Via **BLUETOOTH** we could identify and communicate with up to 50 devices within a max distance of 20m.

Modbus technology

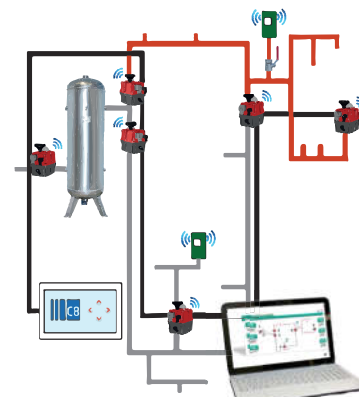

Sectorización MODBUS

- Conecta y listo.
- Se puede actuar manualmente sobre el equipo
- Visible desde el cuadro de control, tablet, móvil, PC, dentro y fuera de la planta.
- Rápido y flexible, podemos empezar con 3 actuadores y ampliar hasta 32.
- Alcance hasta 1.200m.
- Puede alimentar localmente los equipos y comunicarlos con cable de datos.
- Puede nombrar equipos, hacer un sinóptico de planta, mandar mails de alarma.

Sectorización INALÁMBRICA

- Conecta y listo, tan solo alimenta el equipo.
- Se puede actuar manualmente sobre el equipo.
- Visible desde el cuadro de control, tablet, móvil, PC, dentro y fuera de la planta.
- Rápido y flexible, podemos empezar con 3 actuadores y ampliar hasta 32.
- Desde 50m hasta 1.600m sin repetidores.
- Los equipos son emisores y receptores a la vez, creando una malla de comunicación, que permite evitar obstáculos como paredes o interferencias.
- Bajo el protocolo 802.15.4
- Hasta 12 bandas de comunicación, con la posibilidad de cambio de banda en caso de saturación.

MODBUS system

- Plug and Play.
- Each device could be operated manually.
- Could be seen from the control panel, tablet, mobile, PC, either inside or outside of the plant.
- Fast and flexible, starting by 3 actuators up to 32.
- Up to 1,200 m distance range.
- Locally connect the device and communicate with a data cable.
- Could name the devices, make a plant synoptic, send alarm mails.

Wireless system

- Plug and Play.
- Each device could be operated manually.
- Could be seen from the control panel, tablet, mobile, PC, either inside or outside of the plant.
- Fast and flexible, starting by 3 actuators up to 32.
- From 50m up to 1,600 m distance range without repeaters.
- Each device is emitting and receiving at the same time, creating a communication mesh, which enables the device to avoid walls or interferences.
- Under 802.15.4 protocol.
- Up to 12 bands of communication, which allow a change of band in case of saturation.



certificaciones // certifications

| ENSAYOS / TESTS | NORMAS / STANDARD | DIRECTIVAS / DIRECTIVES |
|---|--|--|
| Seguridad Eléctrica Electric Safety | 2014/35/UE (LVD) Low Voltage Directive | UNE-EN 60204-1:2007+Corr:2010 |
| Compatibilidad Electromagnética. Emisiones Electromagnetic Compatibility. Emissions | 2014/30/UE (E.M.C.) | UNE-EN 61000-6-2:2006+E:2009 |
| Compatibilidad Electromagnética. Inmunidad Electromagnetic Compatibility. Immunity | 2006/42/CE | UNE-EN 61000-6-4:2007+E:2008+/A1:2011 |
| Declaración Original de Incorporación para Cuas Máquinas Original Declaration of Incorporation of Partly Completed Machinery | 2006/42/CE | Artículos / Articles: 1.1.2, 1.1.3, 1.1.5, 1.2.1, 1.2.6, 1.3.1, 1.3.7, 1.5.1, 1.6.3, 1.7.1, 1.7.3, 1.7.4 |
| Grados de protección proporcionados por los envoltorios Degrees of protection provided by enclosures | IEC 60 529:2001 (Eg:2.1) UNE 20324:1993 + TM:2000 + ERR: 2004 | 2006/95/CE (Electric Safety, Low Voltage Directive, LVD) 2001/95/CE (Products General Safety) |
| Ensayos vibración Vibration test | UNE-EN 60068-2-6:2008 | UNE-EN 60068-2-6:2008 |

